

PUERTAS BATIENTES / PIVOTANTES

MULTIPUNTO PALANCA BASCULANTE ENTRE EJES 85 mm.

SERIE 296

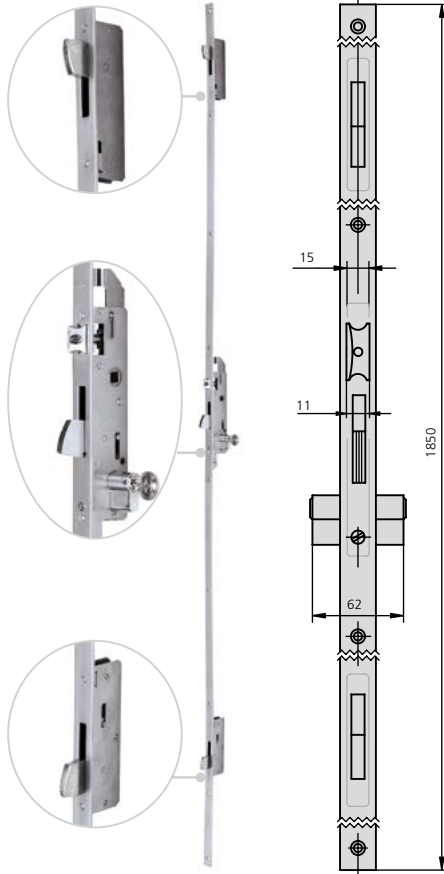

CARACTERÍSTICAS

- Frente liso inox de 1850 x 16mm, 1850 x 22mm, 1850 x 24mm o frente U 1850 x 24,5 x 6mm
- Picaporte reversible de 11 mm
- Picaporte regulable excepto en entrada 25 mm y 28 mm
- Caja de 15 mm
- Cuadradillo de 8 mm
- Tornillo de fijación de cilindro

VERSIONES

- Frente de 2300 mm de largo opcional (serie 496)
- Frente de 1500 mm de largo opcional (serie 596)

ACCESORIOS OPCIONALES

- Gama completa de **cerraderos**
- Gama completa de **cilindros**
- Opción de **cerradero eléctrico**

DESCRIPCIÓN	REF.	MEDIDAS		LEVA	ACABADOS		UDS
		B	A		FRENTE	CILINDRO	

- Picaporte y palanca
- Cilindro no incluido

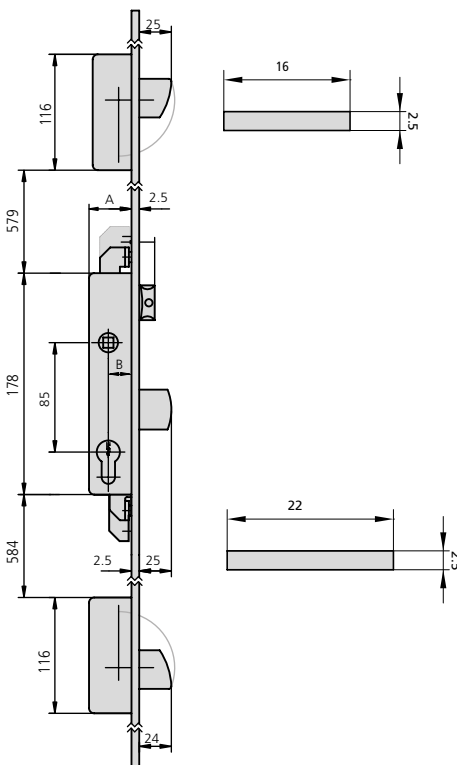

P296/25/6	22	37	15	Al	1
P296/28/6	25	38	13,25	Al	1
P296/30/6	27	42	15	Al	1
P296/33/6	30	43	13,25	Al	1
P296/35/6	32	47	15	Al	1
P296/38/6	35	48	13,25	Al	1
P296/40/6	37	52	15	Al	1
P296/45/6	42	57	15	Al	1
P296/55/6	52	67	15	Al	1

296/25/6L	22	37	15	Al	1
296/28/6L	25	38	13,25	Al	1
296/30/6L	27	42	15	Al	1
296/33/6L	30	43	13,25	Al	1
296/35/6L	32	47	15	Al	1
296/38/6L	35	48	13,25	Al	1
296/40/6L	37	52	15	Al	1
296/45/6L	42	57	15	Al	1
296/55/6L	52	67	15	Al	1

DESCRIPCIÓN	REF.	MEDIDAS		LEVA	ACABADOS		UDS
		B	A		FRENTE	CILINDRO	
	296/25/6LAN	22	37	15	Al		1
	296/28/6LAN	25	38	13,25	Al		1
	296/30/6LAN	27	42	15	Al		1
	296/33/6LAN	30	43	13,25	Al		1
	296/35/6LAN	32	47	15	Al		1
	296/38/6LAN	35	48	13,25	Al		1
	296/40/6LAN	37	52	15	Al		1
	296/45/6LAN	42	57	15	Al		1
	296/55/6LAN	52	67	15	Al		1
		296/25/6U	18	33	15	Al	
296/28/6U		21	34	13,25	Al		1
296/30/6U		23	38	15	Al		1
296/33/6U		26	39	13,25	Al		1
296/35/6U		28	43	15	Al		1
296/40/6U		33	48	15	Al		1
296/45/6U		38	53	15	Al		1
296/55/6U		48	63	15	Al		1



- Sólo palanca
- Cilindro no incluido

	P296A25/6	22	37	15	Al		1
	P296A28/6	25	38	13,25	Al		1
	P296A30/6	27	42	15	Al		1
	P296A33/6	30	43	13,25	Al		1
	P296A35/6	32	47	15	Al		1
	P296A38/6	35	48	13,25	Al		1
	P296A40/6	37	52	15	Al		1
	P296A45/6	42	57	15	Al		1
	P296A55/6	52	67	15	Al		1
		296A25/6L	22	37	15	Al	
296A28/6L		25	38	13,25	Al		1
296A30/6L		27	42	15	Al		1
296A33/6L		30	43	13,25	Al		1
296A35/6L		32	47	15	Al		1
296A38/6L		35	48	13,25	Al		1
296A40/6L		37	52	15	Al		1
296A45/6L		42	57	15	Al		1
296A55/6L	52	67	15	Al		1	

PUERTAS BATIENTES / PIVOTANTES

MULTIPUNTO PALANCA BASCULANTE ENTRE EJES 85 mm.

SERIE 296

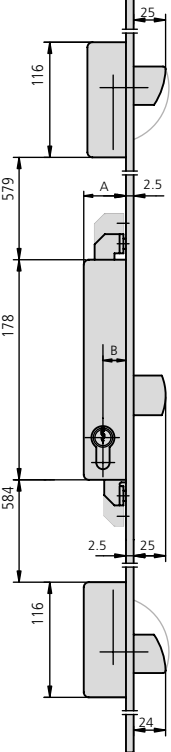
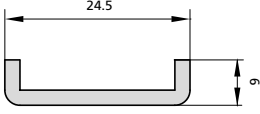
DESCRIPCIÓN	REF.	MEDIDAS		LEVA	ACABADOS		UDS	
		B	A		FRENTE	CILINDRO		
	296A25/6LAN	22	37	15	Al		1	
	296A28/6LAN	25	38	13,25	Al		1	
	296A30/6LAN	27	42	15	Al		1	
	296A33/6LAN	30	43	13,25	Al		1	
	296A35/6LAN	32	47	15	Al		1	
	296A38/6LAN	35	48	13,25	Al		1	
	296A40/6LAN	37	52	15	Al		1	
	296A45/6LAN	42	57	15	Al		1	
	296A55/6LAN	52	67	15	Al		1	
		296A25/6U	18	33	15	Al		1
296A30/6U		23	38	15	Al		1	
296A35/6U		28	43	15	Al		1	
296A40/6U		33	48	15	Al		1	
296A45/6U		38	53	15	Al		1	
296A55/6U		48	63	15	Al		1	

- Rodillo vaivén regulable y palanca
- Cilindro no incluido

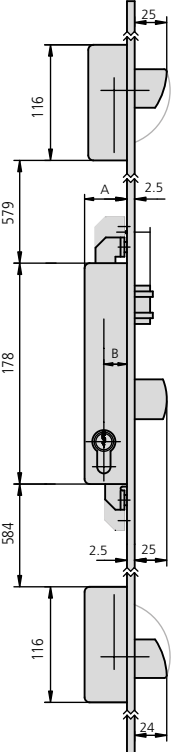
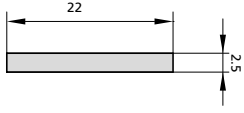
	P296V25/6	22	37	15	Al		1	
	P296V28/6	25	38	13,25	Al		1	
	P296V30/6	27	42	15	Al		1	
	P296V33/6	30	43	13,25	Al		1	
	P296V35/6	32	47	15	Al		1	
	P296V38/6	35	48	13,25	Al		1	
	P296V40/6	37	52	15	Al		1	
	P296V45/6	42	57	15	Al		1	
	P296V55/6	52	67	15	Al		1	
		296V25/6L	22	37	15	Al		1
296V28/6L		25	38	13,25	Al		1	
296V30/6L		27	42	15	Al		1	
296V33/6L		30	43	13,25	Al		1	
296V35/6L		32	47	15	Al		1	
296V38/6L		35	48	13,25	Al		1	
296V40/6L		37	52	15	Al		1	
296V45/6L		42	57	15	Al		1	
296V55/6L	52	67	15	Al		1		

DESCRIPCIÓN	REF.	MEDIDAS		LEVA	ACABADOS		UDS
		B	A		FRENTE	CILINDRO	
	296V25/6LAN	22	37	15	Al		1
	296V28/6LAN	25	38	13,25	Al		1
	296V30/6LAN	27	42	15	Al		1
	296V33/6LAN	30	43	13,25	Al		1
	296V35/6LAN	32	47	15	Al		1
	296V38/6LAN	35	48	13,25	Al		1
	296V40/6LAN	37	52	15	Al		1
	296V45/6LAN	42	57	15	Al		1
	296V55/6LAN	52	67	15	Al		1
		296V25/6U	18	33	15	Al	
296V30/6U		23	38	15	Al		1
296V35/6U		28	43	15	Al		1
296V40/6U		33	48	15	Al		1
296V45/6U		38	53	15	Al		1
296V55/6U		48	63	15	Al		1